



INIVOS

Modular Support Systems

ABOUT US

Engineering a project takes immense investment. Hence, it is supremely significant for any mechanical and infrastructural project to have high quality materials.

We, at Inivos Infratech, understand the needs of high-value infrastructure projects, and therefore provide comprehensive line of solutions in diverse materials and variations.

Supported by an experienced and competent team of engineers, we manufacture following categories of structural support systems:

**Strut Channels and Accessories | Pipe Support Systems | Structural Support Systems
Cable Management Systems | Pyramid Support Systems | General Accessories**

Inivos Infratech's structural support systems are sourced by multitude industries including solar, plumbing, telecom and construction.

Infrastructure:

With its manufacturing unit set up in the industrial belt of Faridabad, to the south of Delhi, Inivos Infratech operates with the strength of its qualified, highly experienced team of engineers who understand the industry at its core.

Our manufacturing unit in Faridabad encompasses range of machines that have been customized for production of high-quality structural support systems for our diverse industry segments. As soon as a customer approaches us, our aim is to provide a hassle-free experience, which begins with understanding the specific metal framing requirements for the project and ends with product delivery that is timely, safe and surpasses expectation.



Slotted



Long Slotted



Half Slotted



Punched



Back to Back

Inivos Infra Tech, at its manufacturing unit in Faridabad, manufactures a range of strut channels primarily used in construction and known for their ability to be assembled very rapidly with minimal tools and less skilled labour, to reduce costs. These strut channels can easily be modified or connected together, with strut specific accessories and connectors.

Advantages of Strut Channels

- Can be assembled rapidly
- Minimal tools requirement
- Moderately skilled labour required
- Diverse modification possibilities

Application:

HVAC/ Electrical/ Plumbing/
Fire Fighting/ Secondary
Structures

Finish:

Pre-Galvanized/ Hot Dip
Galvanized

Material:

Mild Steel

Width:

41 mm

Height Variations:

21 mm
41 mm

Sheet Thickness:

1.5 mm to
2.5 mm

CHANNEL ACCESSORIES

Application:

Designed to fit with strut channels in HVAC/Electrical/Plumbing/Fire Fighting/Construction

Finish:

Electro Galvanized

Material:

Mild Steel



90° Bracket 04



Spring Nut 21



Bracket



Angle Bracket 03



Spring Nut 41



Channel Bracket

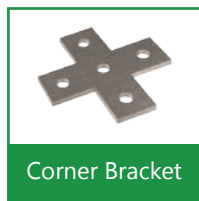

Corner Bracket



Angle Bracket 04



Bracket U



Channel Bracket



90° Bracket 02

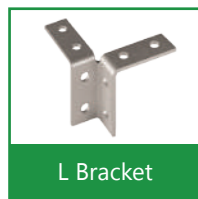

L Bracket



Angle Bracket 04



Bracket



Corner Strut



90° Bracket 03



Channel Bracket



Bracket



Channel



CABLE MANAGEMENT

The Cable Management systems manufactured by Inivos Infra Tech is the key to time management and successful onsite execution.

Application:

1. Supporting insulated electrical cables used for power distribution, control, and communication.
2. Used as an alternative to open wiring or electrical conduit systems, and are commonly used for cable management in commercial and industrial construction

Finish:

Pre Galvanized / Electro Galvanized /
Powder Coated / Hot Dip Galvanized

Cable Tray

Size: 50 mm - 1000 mm

Sheet Thickness: 2.0 mm

Tray Width: 600 mm

Cable Ladder

Size: 50 mm - 1000 mm

Sheet Thickness: 2.5 mm

Ladder Width: 1200 mm

Cable Raceway

Width: 200 mm

Sheet Thickness: 2.5 mm

Minimum Height: 30 mm

Available with/without cover

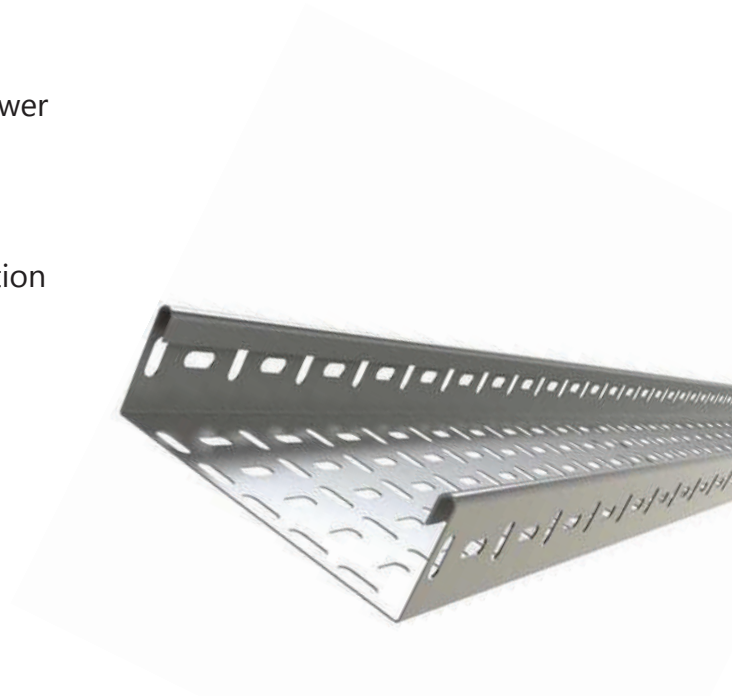

Support Brackets

These Support Brackets are often used for wall, floor and overhead pipe installation. Depending on the site, pipes may lie on the support bracket (U bolt), be arranged in vertical position or be suspended (grub screws).

In combination with bolted-on channels, the support brackets offer a wide range of possibilities for cantilever arrangements.

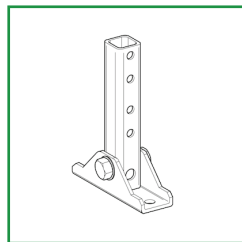
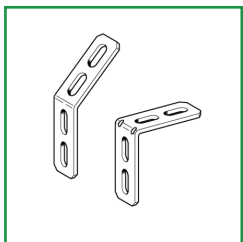
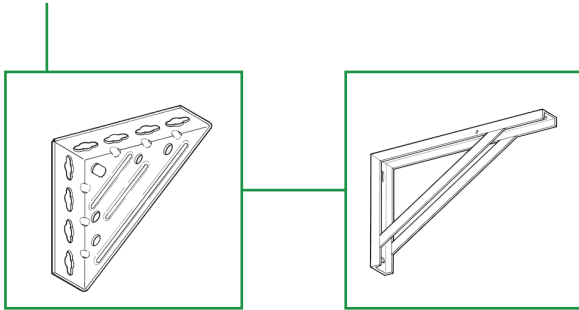

Fixing Bracket

Fixing Brackets act as useful addition to Support Brackets for integration in crossbars and other structures composed of channels with a width of 41 mm

Universal Joint

To be used for connecting Channels MS 41 to optionally bended structures such as tunnels, bended roof frames etc. under different angles. Especially suitable as brace support. Arrangement of the channel opening to all directions is possible.

Tie Rod

Tie Rods cater for the lateral forces applied to Support Brackets. These are used particularly when sliding elements are fixed onto Support Brackets.

Mounting Plate

For wall, ceiling and floor installation of mounting elements in M&E services.

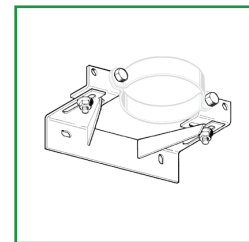
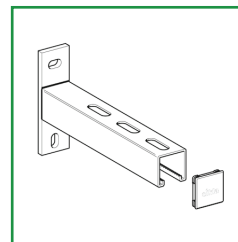
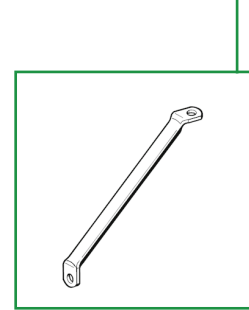
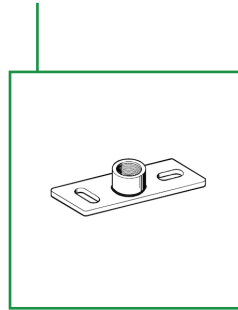

Cantilever Bracket AK

Ready-to-use brackets mainly for mounting pipes to walls.

SFK Bracket

Preferably used in combination with Pipe Clamp Stabil or, if sound absorption is required, with Stabil with Lining Adjustable in two horizontal directions, thus ensuring an exact and tension-free run of vertical pipes.



Universal Beam Clamp

These Beam Clamps can also be customized to include J-hooks on which to hang data communication cables. This is supplied with a high tensile setscrew for a secure grip on both parallel and tapered flanges.

Material: Cast Iron | Finish: Electrogalvanized

Hole Size: 9/11/13/17mm

Electrical Beam Clamps

Electrical Beam Clamp is a cost effective, reliable and durable solution for variety of industrial and residential applications related to mounting of conduits and fixtures to the beam. The conduit clip rotates 360 degrees.



EBC



EBC - MSM



EBC - M



MS Beam Clamp

Multi-functional beam clamp used with Cable/Conduit/Pipe Clamp or Square Washer.



MS Beam Clamp C

With threaded hole on back & bottom, this Beam Clamp made out of steel is an extension of the MS Beam Clamp.



Square Beam Clamp

Connecting element for bilateral fixation of Beam Section, crossbars or cantilevers to steel beams.

Finish: Electro Galvanized

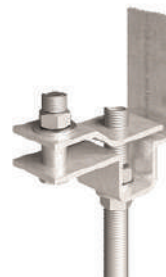

Profile Clamp

Used for Purlin Connections, primarily for Electrical and Light fixtures, upto 50 kg.

Beam Section Holder

Designed to connect 90° intersecting Beam Sections, Beam Section Holders are widely in demand in construction projects. The Beam Section Holder can also be used to connect only one beam section to an even surface with suitable wall anchors or with cast-in channel accessories.

Features:

1. Designed for high accuracy
2. Useful in connecting intersecting beams

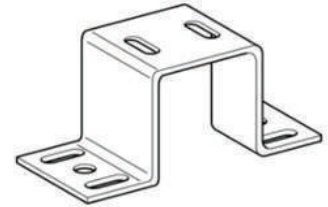

Beam Connection

Beam Connections serve as the medium of connecting assembly for the direct attachment of rod hanger assemblies to beam sections with a flange width 3 15/16" (100-310mm). The pre-welded Eye-Plate serves as a basic element for the connection of the Rod Hanger Load Chain Assembly.

Features:

1. Includes Tightening torque for the U-Holder clamps
2. Type A: Load Chain runs crosswise to the beam
3. Type B: Load Chain runs longitudinally to the beam

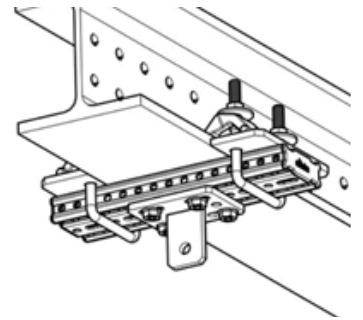

Lifting Point

Inivos Infra Tech is manufacturing export quality structural support systems, like the Lifting Points. These high-strength and highly reliable lifting points can help maximise your permissible load capacities for a range of applications.

Features:

1. Safe working load up to 3t (29.4kN).
2. Large load ring can be set to suit the lift orientation.
3. Adjusts to suit the 5mm to 26mm flange thickness and 70mm to 210mm beam widths.
4. Suitable for parallel and tapered beams up to 10°.



STRUCTURAL ATTACHMENTS

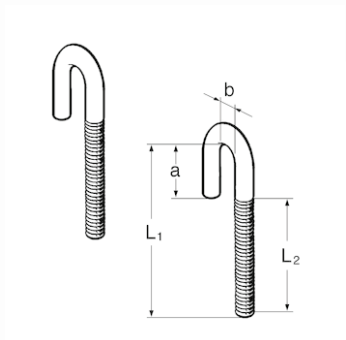
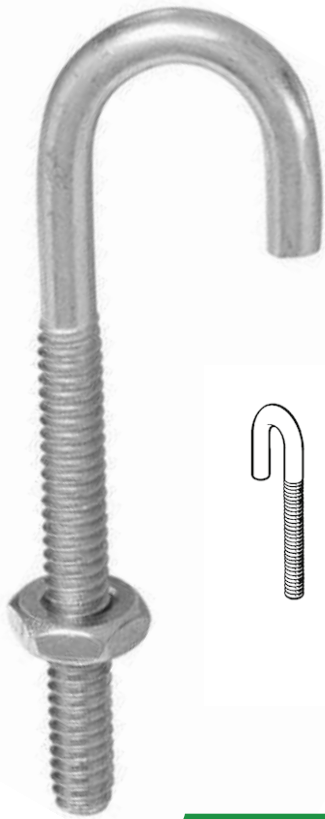

Threaded J Hook

Used in combination with profiled beams as a holder for mounting crossbars composed of Channels or other standard profiles.

Swivel Beam Clamp

Application:

Suitable for mounting onto sloped steel structures

Flange Thickness: 24 mm Max

Finish: Electro Galvanized/Hot Dip Galvanized



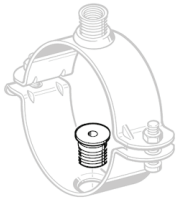

Multi Thread Connector NT 3G

Connecting element for Stabil D-3G Pipe Clamps larger than 31 mm (with sound absorption lining larger than 24 mm) and Stabil D-A up to 303 mm for suspending pipe clamps underneath one another.

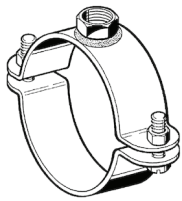

Stabil D-M16

For installation of pipes required for M&E services and in plant construction.

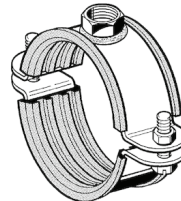

Stabil D-M16 with LINING

For soundproof installation of pipes in M&E services and plant construction.

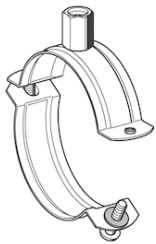

Duo Clamp

Two-piece pipe clamp with double thread connection for the installation of pipelines.

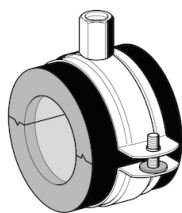

Chilled Water Clamp LKS

Suitable for secure prevention of condensation water at the pipe support location of refrigeration and cold-water pipelines. An optimal diffusion-tight connection with the pipe insulation is easily and safely achieved by fixing usual insulation materials to the clamp faces using adhesive. Recommended up to -0°C at normal ambient condition.



Pipe Loop

For pipeline installations of fixed fire extinguishing systems, mainly used for Sprinkler systems.



Adapter AD

Additional connection options for all Pipe Clamps equipped with triple thread nut, fixed points and threaded tubes.

Inivos Infra Tech manufacturers variety of Pipe Support Systems, whose primary characteristic is its excellent ability to resist corrosion. These Pipe Support Systems are also known for its sturdiness and high tensile strength. We are also supplying these clamps with rubber line as per the required sizes.

Universal Clamp

Application:

1. Hanging lines with varying distances between pipes and calling allow vertical alignment/adjustment of lines even after the installation.
2. Suitable for fire lines, condenser water lines and many more.

Sizes: 20mm - 150mm

Finish:

Pre Galvanized / Electro Galvanized / Powder Coated / Hot Dip Galvanized



Saddle Clamp

Application:

Plumbing/Irrigation/HVAC/Fire-fighting

Sizes: 20mm - 300mm

Finish:

Pre Galvanized / Electro Galvanized / Powder Coated / Hot Dip Galvanized



Strut Clamp

Application:

Plumbing/Irrigation/HVAC/Fire-fighting/
Electrical Conduits/Process Piping/Gas Piping

Sizes: 15mm - 200mm

Finish:

Pre Galvanized / Electro Galvanized / Powder Coated / Hot Dip Galvanized





Split Clamp

Application:

Plumbing/HVAC/Process Piping/Gas Piping -
For secured mounting of pipes to walls/channels/steel sections

Sizes: 3/8" - 6/8" **Finish:** Electro Galvanized



U Bolt

Application:

Fastening rods or angles, these bolts find application in construction, automotive, electrical, railway, metal fabrication and several other engineering sectors

Sizes: 20mm - 600mm **Finish:** Electro Galvanized



Clevis Hanger

Application:

Plumbing/Irrigation/HVAC/Fire-fighting/Electrical
Conduits/Process Piping/Gas Piping

Size: 25mm - 400mm

Finish:

Pre Galvanized / Electro Galvanized /
Powder Coated / Hot Dip Galvanized



Bolt Close Conduit Clamp

Application:

Plumbing/Irrigation/HVAC/Fire-fighting/Electrical
Conduits/Process Piping/Gas Piping

Finish:

Electro Galvanized



GENERAL ACCESSORIES

Inivos Infra Tech is manufacturing a broad assortment of Anchors, Threaded Rods and other general accessories to be used along with channels & clamps.

Features:

- Corrosion resistance
- Fine threading
- Light weight
- Quick installation
- Cost effective
- Enhanced strength



Connector



Washer



Spring Washer



Nut



Lock Nut



Bolt



Bullet Fastener



Hollo Bolt



Shear Connector



Sleeve Anchor



Wedge Anchor



Insulation Anchor

Threaded Rod

Application:

Railway, Wind tower, Secure suspended ceilings, Nuclear power, Automotive industry, Construction and the Electronic Industry

Size: 6/8/10/12/16 mm

Finish:

Pre Galvanized / Electro Galvanized / Powder Coated / Hot Dip Galvanized

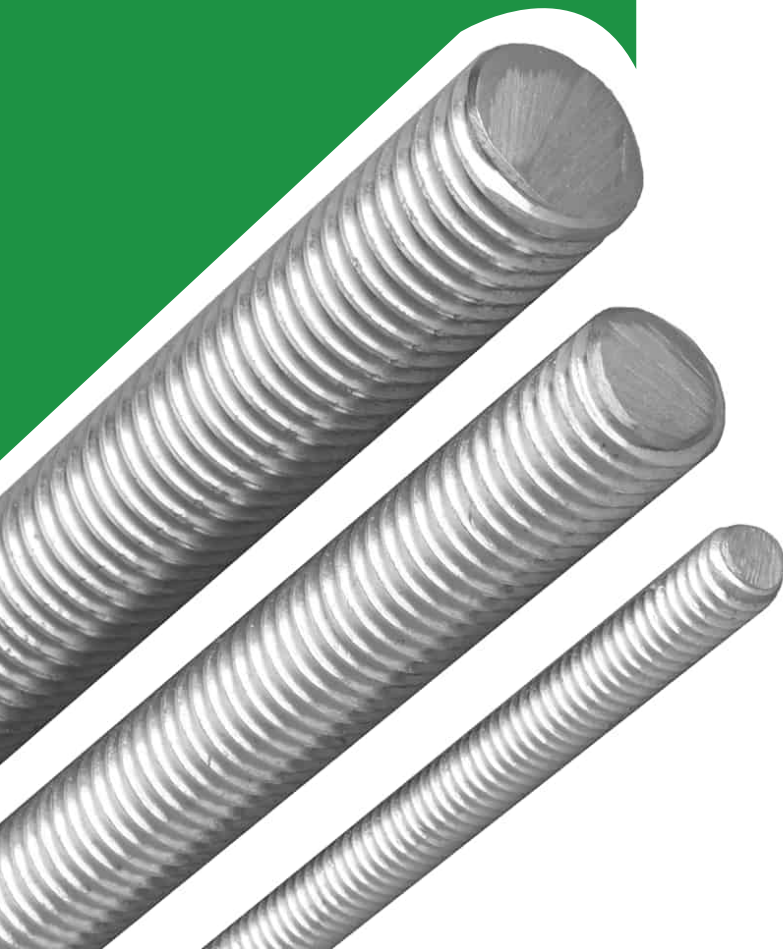

Ducting Clamp PLU 2G

Two-piece pipe clamp for simple installation of spiral-seam ducts.

Ducting Clamp PLU 2G with LINING

Two-piece pipe clamp for simple installation of spiral-seam ducts. Suitable for soundproof installation.

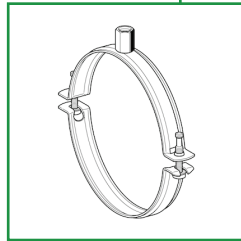
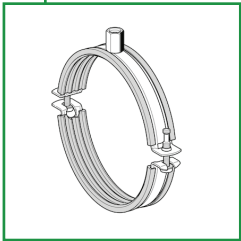

Ducting Clamp PLU

Ducting Clamp designed for installing spiral-seam ducts for industrial ventilation systems.

Ducting Clamp PLU with LINING

Designed for installing spiral-seam ducts for industrial ventilation systems, For soundproof installation.

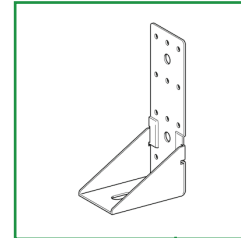
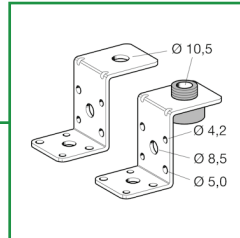
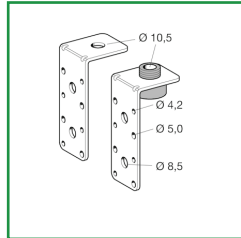
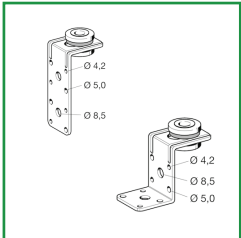
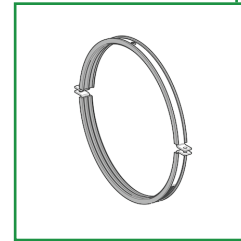
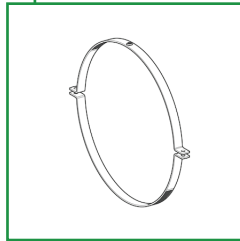

Ducting Angle LUW

Designed for installing spiral-seam ducts for industrial ventilation systems
For soundproof installation of pipes.

Ducting Angle LUW Stabil

Mounting element for rectangular, particularly for vertically running ducts. In combination with Sound Absorber, suitable for soundproof fixing of ducts.

Ducting Angle LUW A

Mounting Angle for rectangular ducts installed directly under the ceiling, or for suspended installation when using a threaded rod.

PYRAMID SUPPORT



Rubber Based Support

- Quick height adjustment accommodates for uneven roofs or sloped condensate lines
- No tools or fasteners needed; fast snap-on installation
- Design sheds water and helps reduce pipe corrosion
- Roof-friendly; made of UV-stabilized EPDM material



Adjustable Strut Support

- Strut-based thermoplastic support designed specifically for rooftop applications
- Provides superior support for pipe, conduit, duct, cable tray and equipment
- Solid bottom surface protects the roof membrane from damage caused by concentrated pressure
- Offers excellent load distribution with high load ratings
- Base is manufactured from UV-stabilized thermoplastic material
- Engineered for long-lasting performance



Equipment Support Clamp

- Ideal for use with strut channel type A and square tube to create custom equipment supports
- Slotted design offers fast and easy installation



Equipment Support Kit

- Kit includes post-base assemblies, frame and equipment-support clamps
- Assembles and adjusts to size and height in minutes by one person with one tool
- Innovative crossbar and equipment-support clamps enable quick assembly
- Integral foam pad provides gentle interface for all roof types
- Hot-dip galvanized finish provides superior corrosion protection
- Assembled support can be lifted as one unit and easily relocated
- Available in 4- or 6-post base configurations



Equipment Support Post Base

- Ideal for use with strut channel type A and U-shaped brackets to create custom equipment supports
- Height adjustable
- Innovative base design evenly distributes load to help prevent damage to roof membrane
- Base is manufactured from UV-stabilized thermo-plastic material



Support Systems for **Resilient** Structures



Inivos Infra Tech Pvt Ltd

Plot No. 3, Northern India Industrial Complex,
Sector – 05, Main Mathura Road, Faridabad, Haryana – 121002

www.inivosinftratech.com

info@inivosinftratech.com | sales@inivosinftratech.com

+91 129 4012320, +91 8882900410, +91 99994 71702